

FOLD-OUT BED

WHAT'S IN THE BOX?

	A	B (Optional)	C (Optional)	D (Optional)
70 cm	16x Bedframe	2x Side	2x Top	
80 cm	16x Bedframe	2x Side	2x Top	
90 cm	16x Bedframe	2x Side	2x Top	
140 cm	32x Bedframe	2x Side	4x Top	2x Connecting piece
160 cm	32x Bedframe	2x Side	4x Top	2x Connecting piece
180 cm	32x Bedframe	2x Side	4x Top	2x Connecting piece

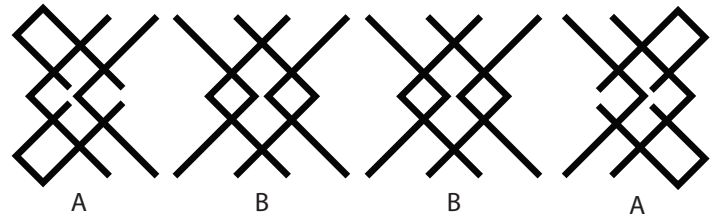
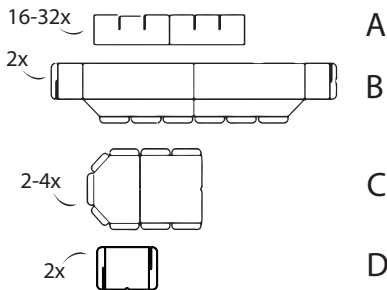
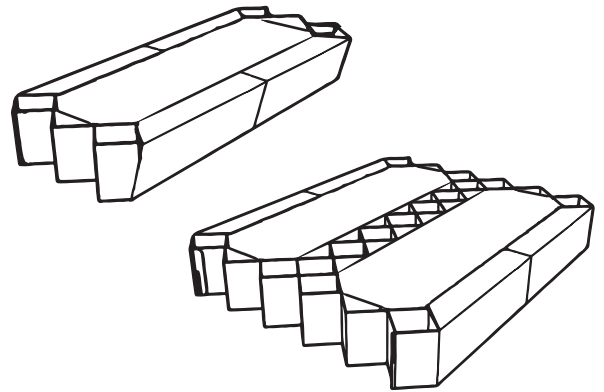

1. Check that you have all the parts. The edge B, top C and the connector D are optional.

2. The frame consists of 4 parts. The front and rear parts (A) are the same, and are connected to the middle parts (B). See image for the overview.

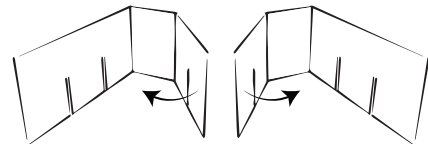
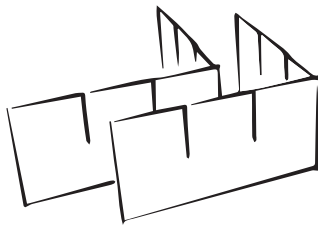

3. Lay out 2 pieces of bed A as shown, with the incisions facing up.

4. Fold 2 pieces mirrored over 1 of the 2 inner incisions. Apply a fold line yourself.

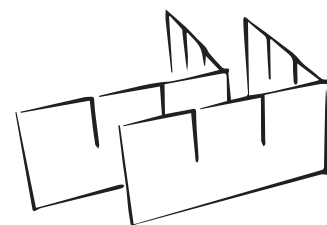
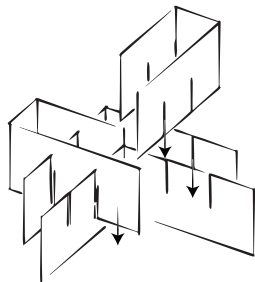

5. Attach the folded parts to the laid out pieces as shown. Part A is now finished.

6. To make part B, lay out 2 bed pieces A as shown, with the incisions facing up.

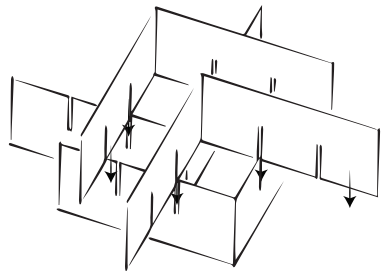

7. Add 2 pieces over the laid out pieces as shown. Part B is now finished.

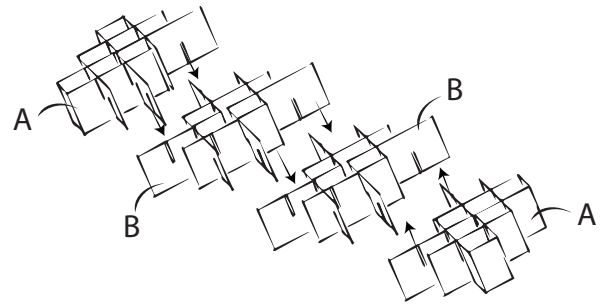

8. Now attach the 2 parts A and the 2 parts B to each other by sliding the slots together.

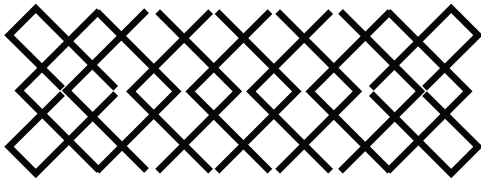

9. The frame should now look something like this from above. If this is incorrect, check that your parts A and B are correct.

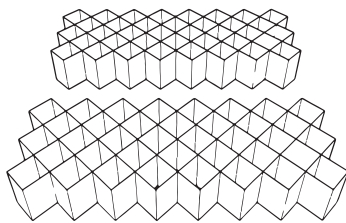

10. **Steps 10 to 13 are only for beds wider than 90cm**
Repeat steps 1 to 9 and place the 2 beds next to each other.

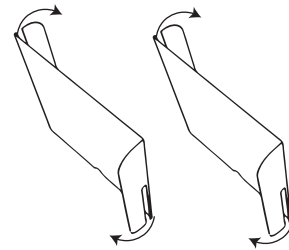

11. Fold the connectors as above.

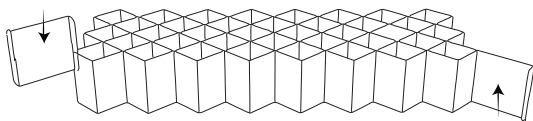

12. Slide the connectors into the rear bunk

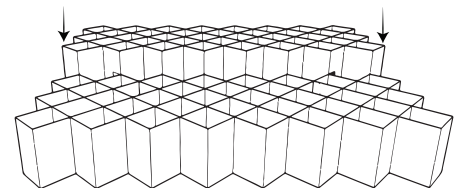

13. Then slide the other bed over the connectors.



2x

14. **Steps 14 to 18 are optional.**
Fold the flaps of leg B inwards.

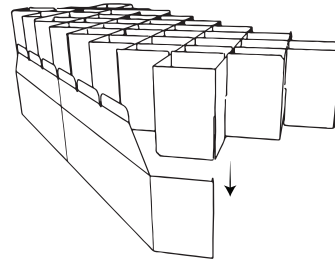

2x

15. Attach the frame to the sides B.
Make use of the slots. Do this on both sides.

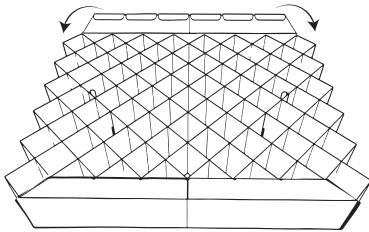

2x

16. Fold the flaps of side B inwards
and slide into the frame.

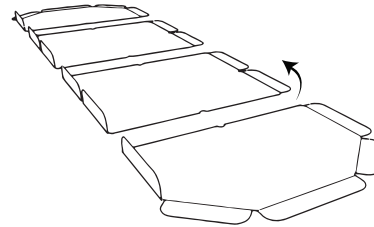

17. Fold the flaps from top of face C
inwards.

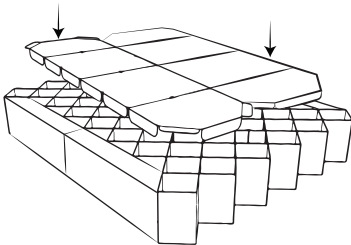

18. Finally, place the top surface C
on the frame and the fold-out
bed is finished!