

LIGHT LETTER

WHAT'S IN THE BOX?

- 1x Letter board A
- 1x 10 lamps on cord B

ADD IT YOURSELF

- 3x AA batteries

CAUTION! The letters H, K and Y come with 1 Lampshade.

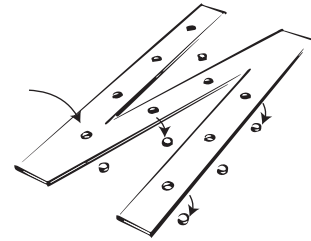
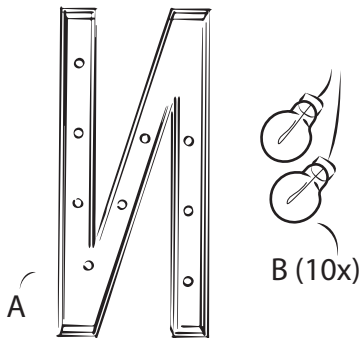
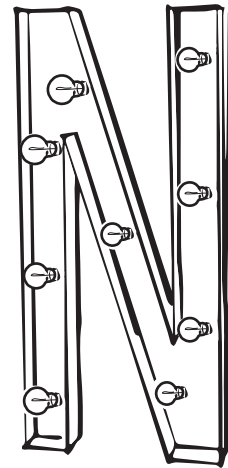

1. Check that you have all the parts. Put the batteries in the bulb and check that all the bulbs are working. **CAUTION:** The warranty is void if the lamps are installed without prior checking.

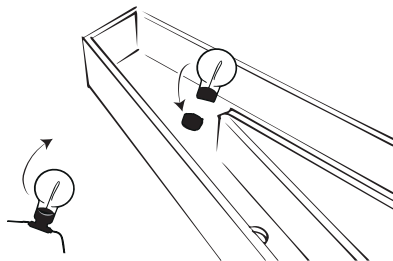

2. Break out any loose parts.

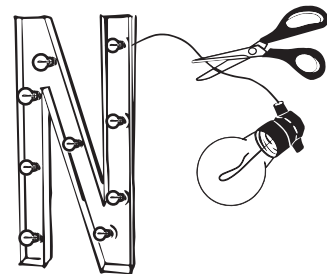

3. Unscrew the bulb from the socket and then insert it through the hole from behind, now screw the bulb back in. The lamp route can be found on the back of Letterbord. **CAUTION:** The LED filament is very fragile. Therefore, be careful when screwing the lamp bulb on and off.

4. Cut off the last bulb(s) from the cord, if you have any bulbs left.

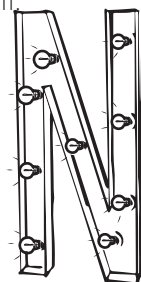

Optional step

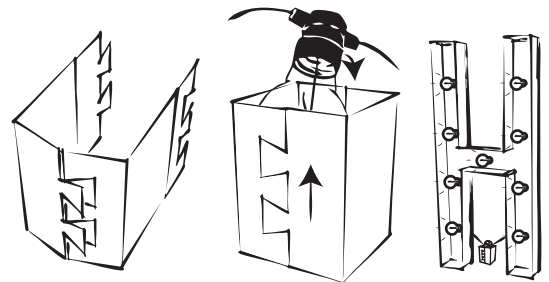

5. Add the batteries, turn on the lights, and your light letter is ready to shine.

6. Fold the box together and slide the lampshade onto the lamp(s) hanging between the letters H, K and Y.