

Arch bed

WHAT'S IN THE BOX?

80cm	3x Leg part	4x Arch part	2x Support beam
90cm	3x Leg part	4x Arch part	3x Support beam
120cm	3x Leg part	5x Arch part	4x Support beam
140cm	3x Leg part	5x Arch part	4x Support beam
160cm	3x Leg part	6x Arch part	5x Support beam
180cm	3x Leg part	6x Arch part	5x Support beam
200cm	3x Leg part	7x Arch part	6x Support beam

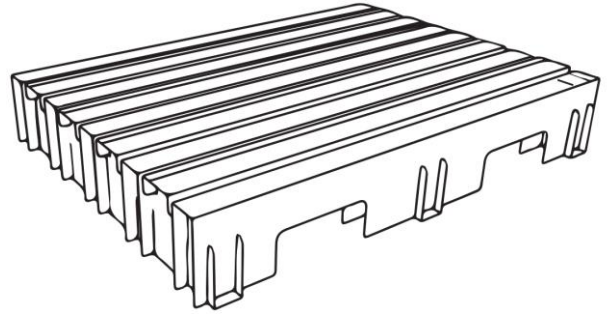

Attention!

Make sure the fold line is visible up and then fold the cardboard towards you.

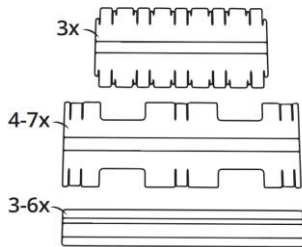

1. Check if you have all the parts. The amount of parts depends on the size of the bed.

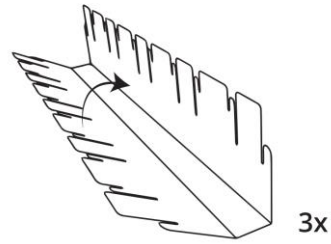

2. Prepare the legs by folding them over the fold lines as shown.

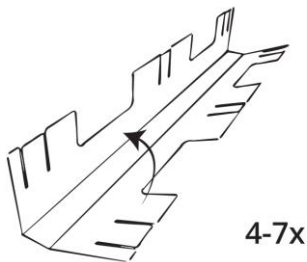

3. Do the same for the arch parts of the bed.

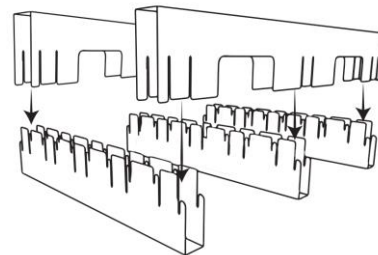

4. Slide two arches into the outer slots as shown.

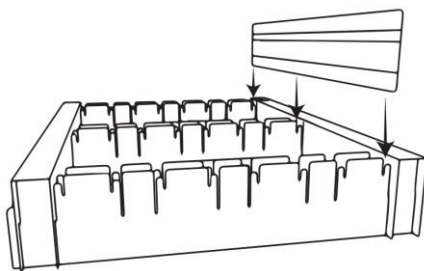

5. Slide the support beams in the destined slots.

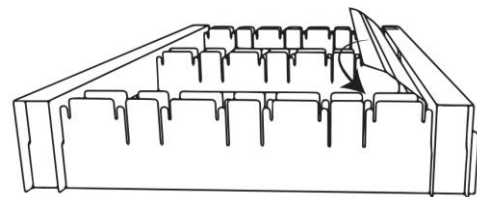

6. Then fold the support beam in over the fold line and slide it into the next slot.

Drawer for arch bed

WHAT'S IN THE BOX?

- 1x Body A
- 1x Back B
- 1x Front C

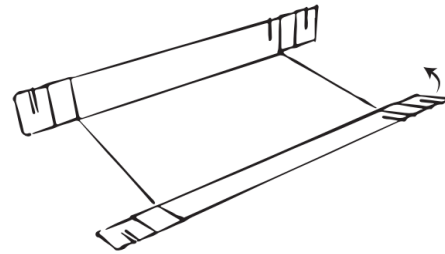
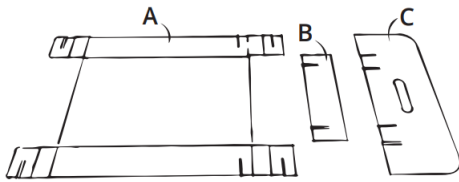
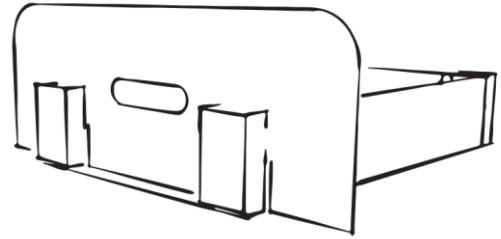

1. Check if you have all the parts.

2. Fold up the sides of the body A.

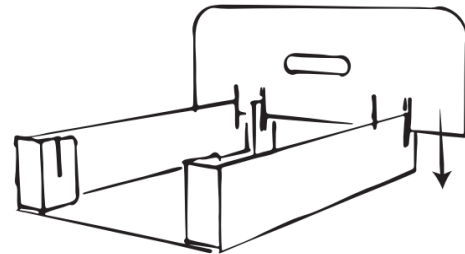
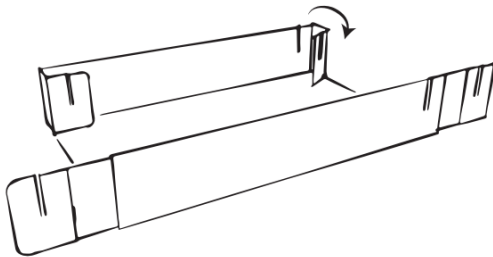

3. Fold the flaps at the front and back inwards. Do this on both sides.

4. Fit the front C in the slots provided.

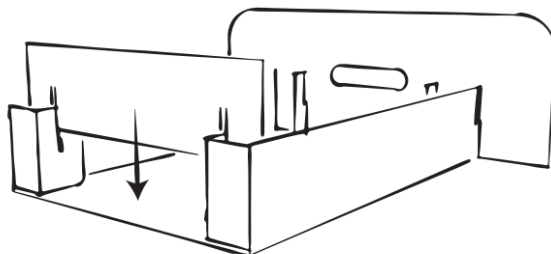

5. Fit the back B in the slots provided. Your drawer is ready!