

WARDROBE

WHAT'S IN THE BOX?

- | | |
|-------------------------------------|-------------------------------|
| 1x Vertical Wall Left A | 1x Wooden stick H |
| 1x Vertical center of wall B | Optional parts |
| 1x Vertical Wall Right C | 2x Drawer I |
| 1x Wide shelf D | 1x Door left J |
| 2x Narrow shelf E | 1x Door on the right K |
| 4x Back F | |
| 1x Top G | |

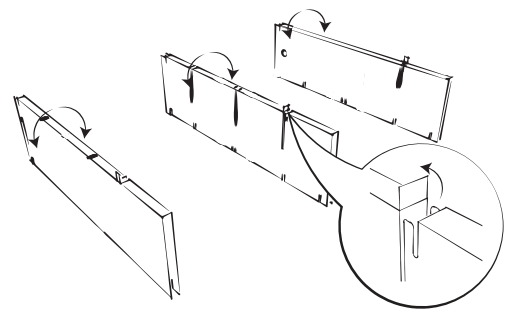
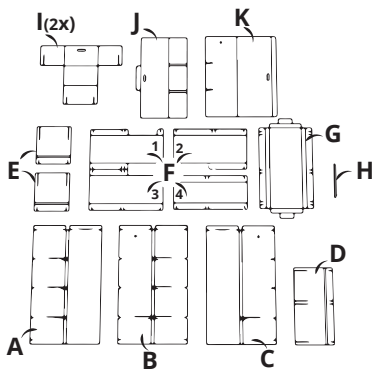
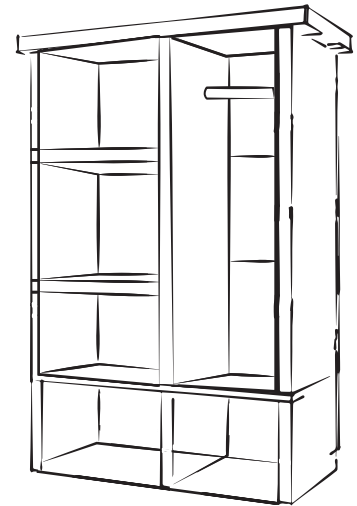

1. Check if you have all the parts.

2. Fold the verticals A, B and C over the fold lines. Fold the tabs up at the incisions.

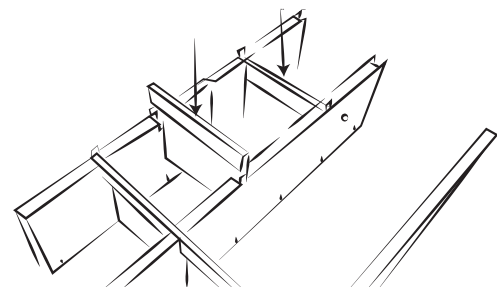
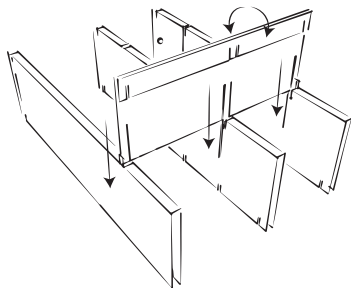

3. Fold the wide board D over it. Fold the lines and slide it into incisions at the bottom of the vertical Walls.

4. Fold the narrow boards E around the fold lines and slide it into the other cuts in the walls.

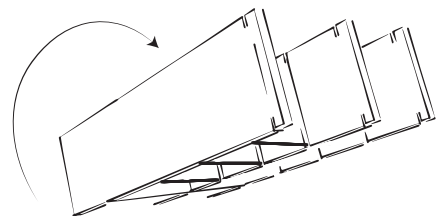
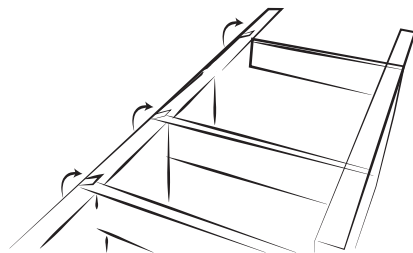

5. Fold all tabs down so the incisions are no longer visible.

6. Turn the entire cabinet over so it's on its front.

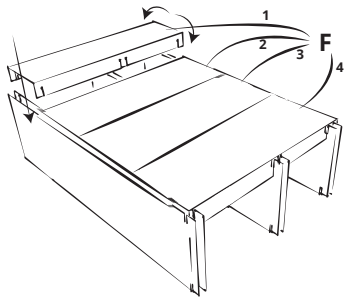

7. Fold parts F back over the fold lines and insert into the cuts in the back.

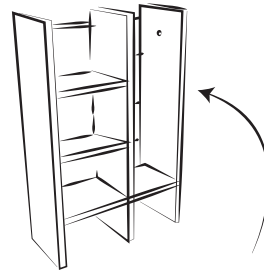

8. Stand the cabinet upright.

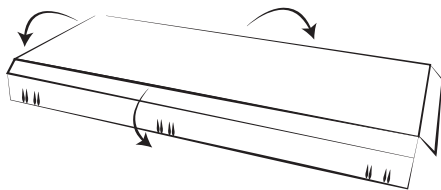

9. Falten Sie die Laschen des oberen G über die Faltlinien



10. Attach the top G to the cabinet by folding over the flaps. Do the long sides first and then the short sides.

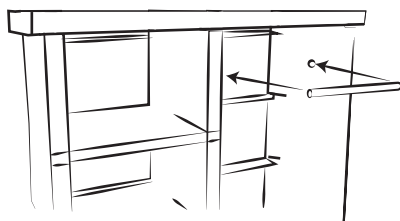

Optional Steps

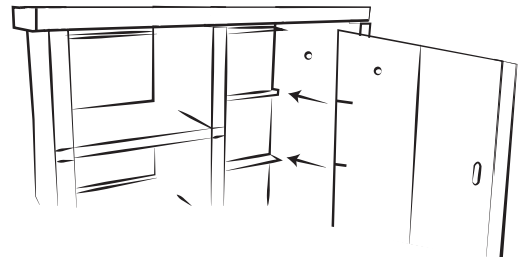

11. Insert the wooden stick into the holes between the right and middle wall and the wardrobe is done!

12. Slide the doors between the outer walls as shown. Then follow step 11 and continue to step 13.

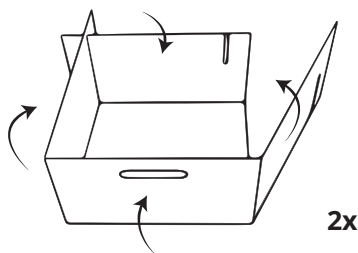

13. Fold the drawer over the fold line and slide the sides into the slots in the back.

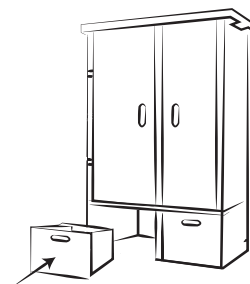

14. Place the drawers under the closet and the closet is done!