

# LOUNGE CHAIR

## WHAT'S IN THE BOX?

- 3x Base part A
- 4x Base part B
- 1x Part C
- 1x Part D
- 1x Part E
- 1x Part F
- 1x Part G
- 1x Part H

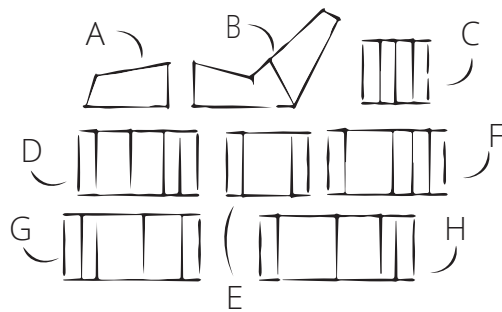
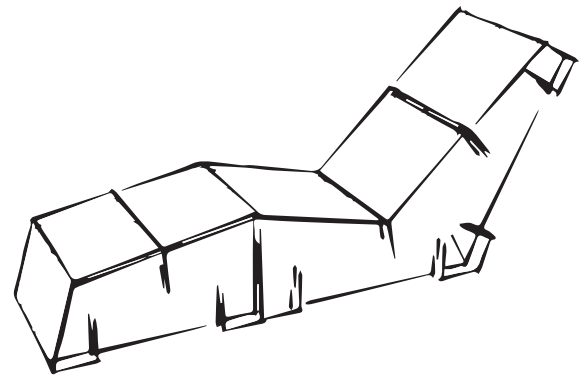

1. Check that you have all the parts. And take a good look at which part is which. You can see this by the difference between the fold lines and the number of fold lines.

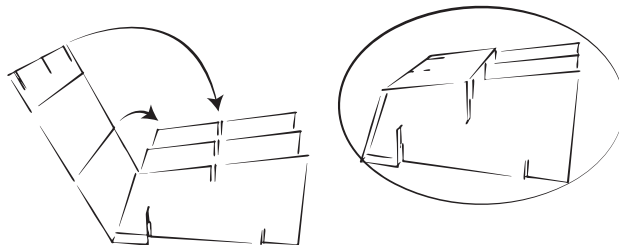

3. Fold part D around part A so that the cuts of D can fit into the top cutouts of A.

2. First, take part D and fold up the part with the cutouts that is next to the smallest compartment and place the three parts A in the incisions of the folded part.

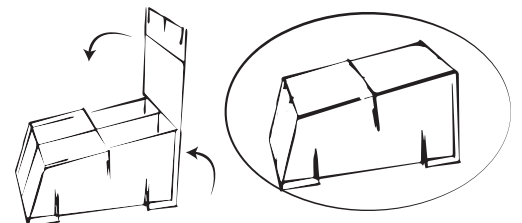

4. Now take part G and fold it around A on the other side in the same way as you did with part D.

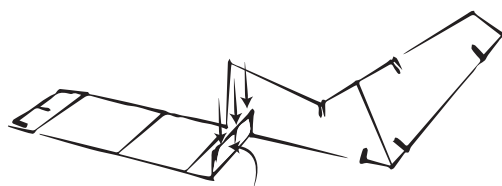

5. Take part H and, just like in step 2, fold up the side and place the three parts B in the 3 cut-outs of the folded side.

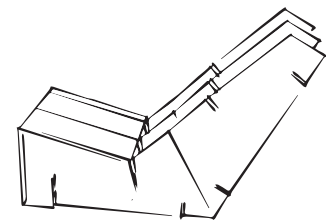

6. Just like in step 3, fold it through so that the cutouts of H are in those of B.

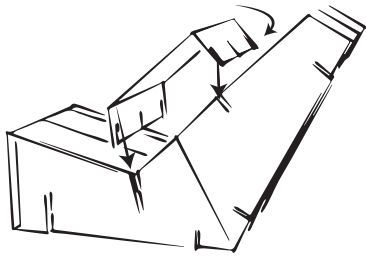

7. Now take part E and fold the ends downwards. Now slide one end into the cutouts of B that also contains the end of H. Put the other end in the following cutouts.

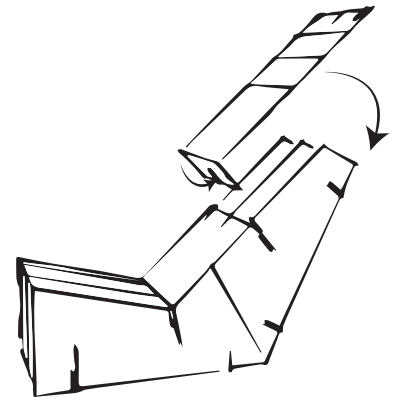

8. Now take part F and fold over the part with the cutouts which is next to the large compartment and insert it into the cutouts of B where you just put E.

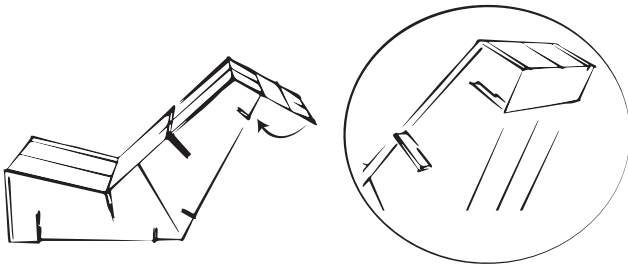

9. Fold F around B and insert the end into the cutouts of B.

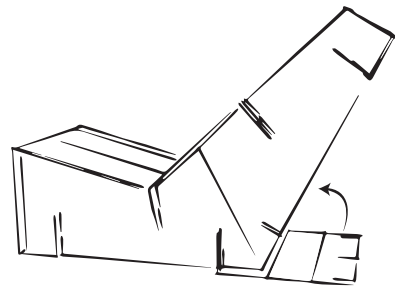

10. Finally, fold part E and insert the ends into the two empty cutouts at the bottom of the B.

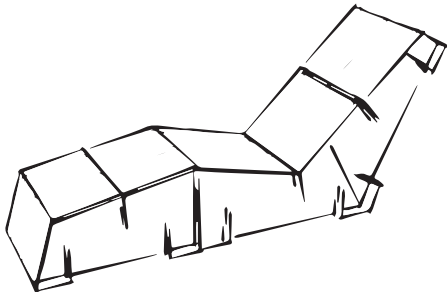

11. Finally, slide the block of part A against that of B and then your lounge chair is finished!